

Werkzeugkatalog

tool catalogue

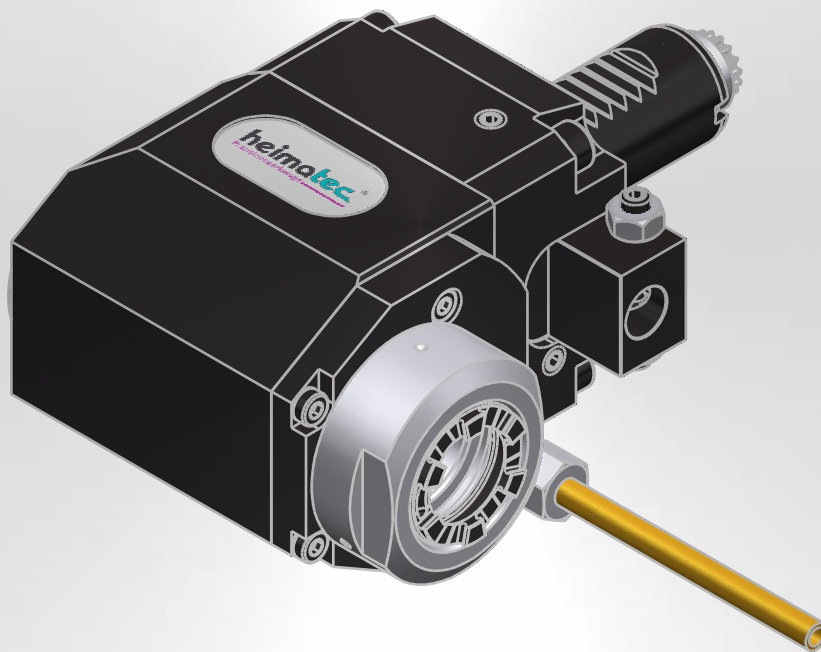

APEX

Revolver / turret VDI 25 - DIN 5480

PT - 12



Hinweis zu den AGBs:

Diese finden Sie in unserem Internetauftritt unter

www.heimatec.de

Home/Impressum/AGB

Terms and conditions:

You will find them on our website

www.heimatec.com

Home/Imprint/Terms and Conditions

Das Katalog-Werk einschließlich aller seiner Teile ist urheberrechtlich geschützt. Jede Verwertung außerhalb der engen Grenzen des Urheberrechtsgesetzes ist ohne Zustimmung der Rechteeinhaber unzulässig und strafbar. Das gilt insbesondere für Vervielfältigungen, Übersetzungen, Mikroverfilmungen und die Einspeicherung und Verarbeitung in elektronischen Systemen.

heimatec® GmbH behält sich Änderungen technischer Art jederzeit ohne Vorankündigung vor. Dies gilt insbesondere bei Anpassungen an neue oder geänderte internationale Normen oder bei Weiterentwicklungen unserer Produkte oder Herstellungsprozesse.

This catalogue, including all its parts, is protected by copyright. Each use outside the restricted limitations of the Copyright Act is inadmissible and liable to prosecution without the consent of heimatec. This is particularly valid for duplication, translation, microfilming and feeding and processing in electronic systems.

heimatec® GmbH reserves the right of technical changes everytime without advance notice, which is particularly valid for adaptions to new or changed international standards, or to developments of our products or manufacturing processes.

angetriebene Werkzeuge
driven tools



Axial-Bohr- und Fräskopf
axial drilling and milling head

$n_{max} = 6000 \text{ min}^{-1}$

8 010 25 083	ER 25 AX u-tec	EK	1:1
8 010 25 082	ER 25 AX u-tec	IK 25 bar	1:1
8 010 26 009	easy quick HT 4	EK	1:1
8 010 26 010	easy quick HT 4	IK 25 bar	1:1



Axial-Bohr- und Fräskopf
axial drilling and milling head

$n_{max} = 24000 \text{ min}^{-1}$

8 013 24 020	ER 16 AX u-tec	EK	1:4
8 013 24 031	ER 16 AX u-tec	IK 70 bar	1:4



Axial-Fräskopf
axial milling head

$n_{max} = 6000 \text{ min}^{-1}$

8 011 24 009	Kombidorn/universal arbor 16	EK 1:1	
8 011 25 006	Kombidorn/universal arbor 22	EK 1:1	



Axial-Bohr- und Fräskopf
axial drilling and milling head

Achsversatz / offset $A=34,5$

$n_{max} = 12000 \text{ min}^{-1}$

8 016 24 009	ER 16 AX u-tec	EK	1:2
8 016 24 015	ER 16 AX u-tec	IK 140 bar	1:2
8 016 24 010	easy quick HT 2	EK	1:2
8 016 24 016	easy quick HT 2	IK 140 bar	1:2

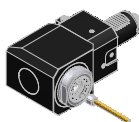

Winkel-Bohr- und Fräskopf
radial drilling and milling head

Mittenmaß / center distance $H=75$

$n_{max} = 6000 \text{ min}^{-1}$

8 036 25 000	ER 25	EK	1:1
8 036 25 005	ER 25	IK 140 bar	1:1
8 036 25 017	ER 25 AX u-tec	EK	1:1
8 036 25 022	ER 25 AX u-tec	IK 140 bar	1:1
8 036 26 003	easy quick HT 4	EK	1:1
8 036 26 022	easy quick HT 4	IK 140 bar	1:1

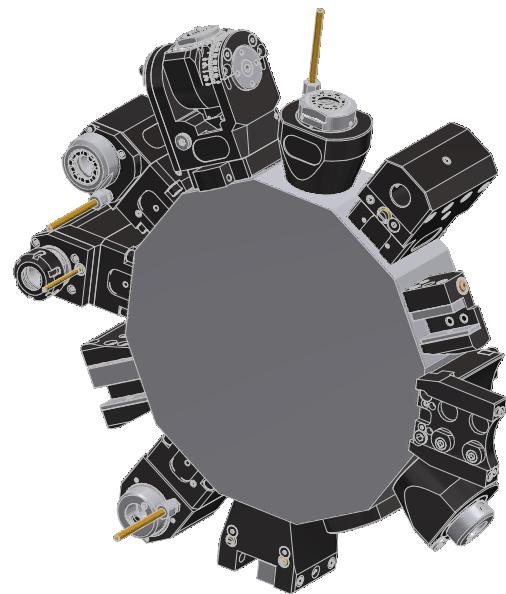

Winkel-Bohr- und Fräskopf
radial drilling and milling head

Mittenmaß / center distance $H=75$

$n_{max} = 6000 \text{ min}^{-1}$

8 036 24 031	Kombidorn/universal arbor 16	EK 1:1	
8 036 25 049	Kombidorn/universal arbor 22	EK 1:1	



Winkel-Bohr- und Fräskopf
radial drilling and milling head

Mittenmaß / center distance $H=75$

doppelspindlig / double spindle

$n_{max} = 6000 \text{ min}^{-1}$

8 039 25 016	ER 25	EK	1:1
8 039 26 020	easy quick HT 4	EK	1:1

► Weitere Ausführungen auf Anfrage
further versions on request

► Zubehör **ZB...***
accessories **ZB...***

► **easy-quick**

► **u-tec**



Schwenkkopf universal head

$n_{max} = 6000 \text{ min}^{-1}$

8 040 24 022 ER 16 EK 1:1

Mittenmaß / center distance H=55

8 040 24 021 ER 16 EK 1:1

Mittenmaß / center distance H=70



Schwenkkopf universal head

Mittenmaß / center distance H=87

8 040 24 095 ER 16 AX u-tec EK 1:1

8 040 24 096 ER 16 AX u-tec IK 140 bar 1:1

$n_{max} = 6000 \text{ min}^{-1}$

8 040 24 093 ER 16 AX u-tec EK 1:2

8 040 24 062 ER 16 AX u-tec IK 140 bar 1:2

$n_{max} = 12000 \text{ min}^{-1}$

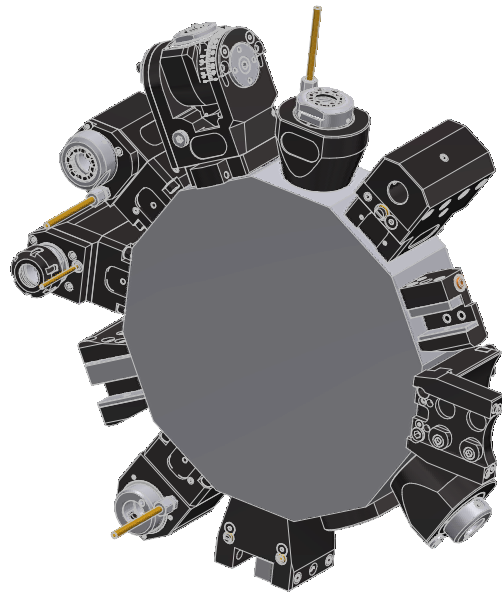

Winkel-Scheibenfräserkopf radial disk mill head

Mittenmaß / center distance H=88

$n_{max} = 2000 \text{ min}^{-1}$

Lieferung ohne Fräserwelle / delivery without milling arbor

8 037 29 037 $\varnothing 8 - \varnothing 22$ EK 2,55:1

festе Werkzeuge static tool holders



Werkzeughalter C1 tool holder C1

8 214 22 004 Vierkant/square 20/16 EK



Werkzeughalter C2 tool holder C2

8 215 22 003 Vierkant/square 20/16 EK

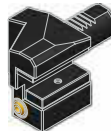

Werkzeughalter C3 tool holder C3

8 214 22 003 Vierkant/square 20/16 EK



Werkzeughalter C4 tool holder C4

8 215 22 002 Vierkant/square 20/16 EK

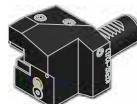

Werkzeughalter C1 / C4 tool holder C1 / C4

8 216 22 000 Vierkant/square 20/16 EK

► Weitere Ausführungen auf Anfrage
further versions on request

► Zubehör ZB...*
accessories ZB...*



► easy-quick



► u-tec



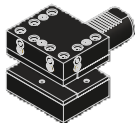

Werkzeughalter D1
tool holder D1
8 274 21 001 **Vierkant/square 20/16** EK

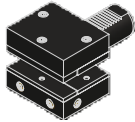

Werkzeughalter D2
tool holder D2
8 274 21 002 **Vierkant/square 16/12** EK



Kombi-Doppel-Drehstahlhalter
combi double turning holder
8 251 23 003 **Vierkant/square 16/12** EK



Kombi-Plandrehhalter
combi facing holder
8 234 24 004 **Vierkant/square 20** EK

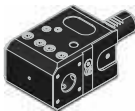

Bohrstangenhalter
boring bar holder
*Mittenmaß / center distance H=75
rechts / right*
8 230 27 024 **ø25** IK/EK
8 230 28 017 **ø32** IK/EK



Bohrstangenhalter
boring bar holder
*Mittenmaß / center distance H=75
links / left*
8 231 27 002 **ø25** IK/EK
8 231 28 001 **ø32** IK/EK



Doppel-Bohrstangenhalter
double boring bar holder
Mittenmaß / center distance H=75
8 239 26 032 **ø20** IK/EK
8 239 27 017 **ø25** IK/EK

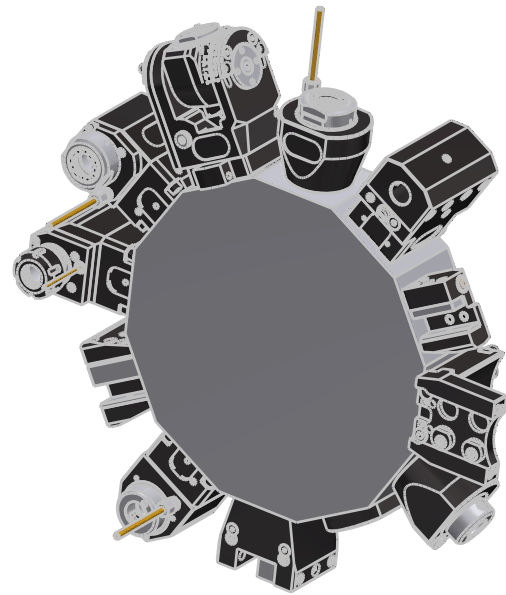

Spannzangenhalter
collet chuck holder
Mittenmaß / center distance H=75
8 236 25 000 **ER 25** IK/EK
8 236 26 003 **ER 32** IK/EK





Doppel-Spannzangenhalter
double collet chuck holder
Mittenmaß / center distance H=75
8 239 25 007 **ER 25** IK/EK
8 239 26 010 **ER 32** IK/EK



Aufnahmehalter
tool holder
Mittenmaß / center distance H=75
8 236 26 002 **easy quick HT 4** IK/EK

► Weitere Ausführungen auf Anfrage
further versions on request

► Zubehör **ZB...***
accessories **ZB...*** 

► **easy-quick** 

► **u-tec** 

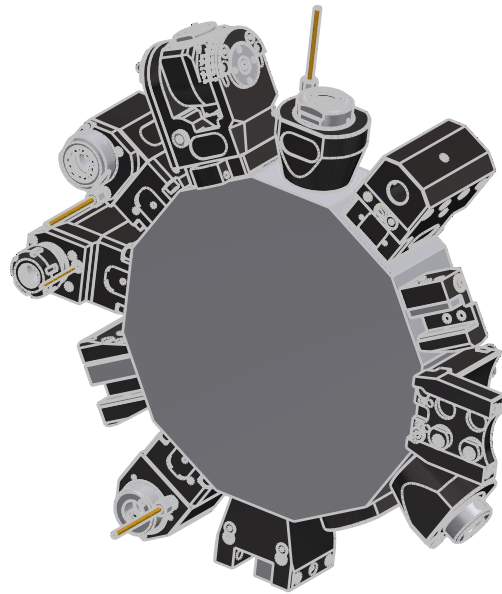

Doppel-Aufnahmehalter
double tool holder

Mittenmaß / center distance H=75

8 239 26 029 **easy quick HT 4** IK/EK



Werkstoffanschlag
stock stop

Mittenmaß / center distance H=75
rechts / right

8 262 29 015 **ø 60**



Werkstoffanschlag
stock stop

Mittenmaß / center distance H=75
links / left

8 262 29 006 **ø 60**



Abstechhalter
cut-off holder

höhenverstellbar / height adjustable

8 320 22 007 **SH 26** EK

8 320 23 006 **SH 32** EK

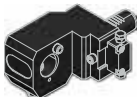

Adapter für VDI
adapter for VDI

Mittenmaß / center distance H=75
rechts / right

8 209 22 012 **VDI 25** EK

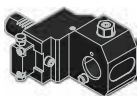

Adapter für VDI
adapter for VDI

Mittenmaß / center distance H=75
links / left

8 209 22 013 **VDI 25** EK





Verschlussstopfen Z2
plug Z2

8 200 20 012 **25 K**

8 200 20 004 **25 S**

▶ Weitere Ausführungen auf Anfrage
further versions on request

▶ Zubehör **ZB...***
accessories **ZB...*** 

▶ **easy-quick** 

▶ **u-tec** 

► **easy-quick HT Schnellwechselsystem**
easy-quick HT fast change system

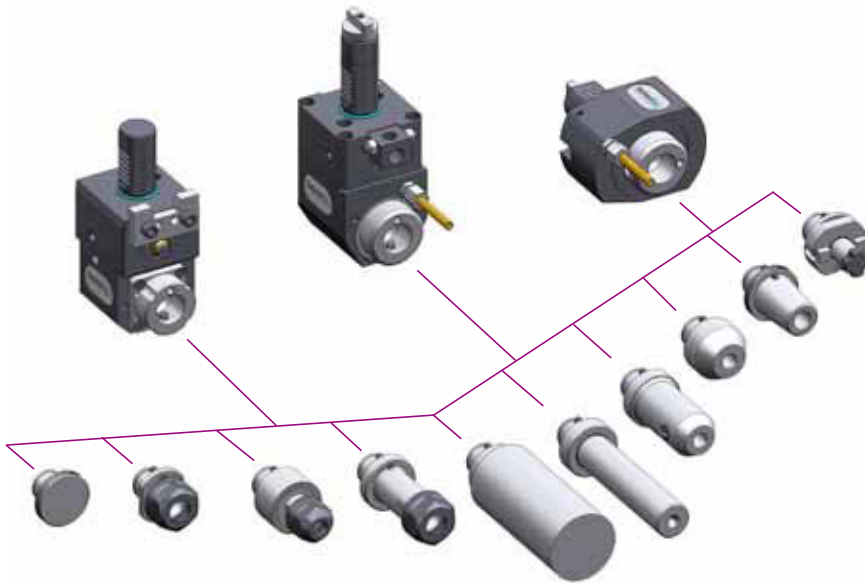

DAS Schnellwechselsystem von heimatec
für angetriebene und feste Werkzeuge

*THE fast change system of heimatec
for driven and static tools*

www.heimatec.de
Produkte / easy-quick

www.heimatec.com
products / easy-quick

► Ausführungen siehe Katalog
versions see catalogue



► **u-tec[®] UT Wechselsystem**
u-tec[®] UT change system

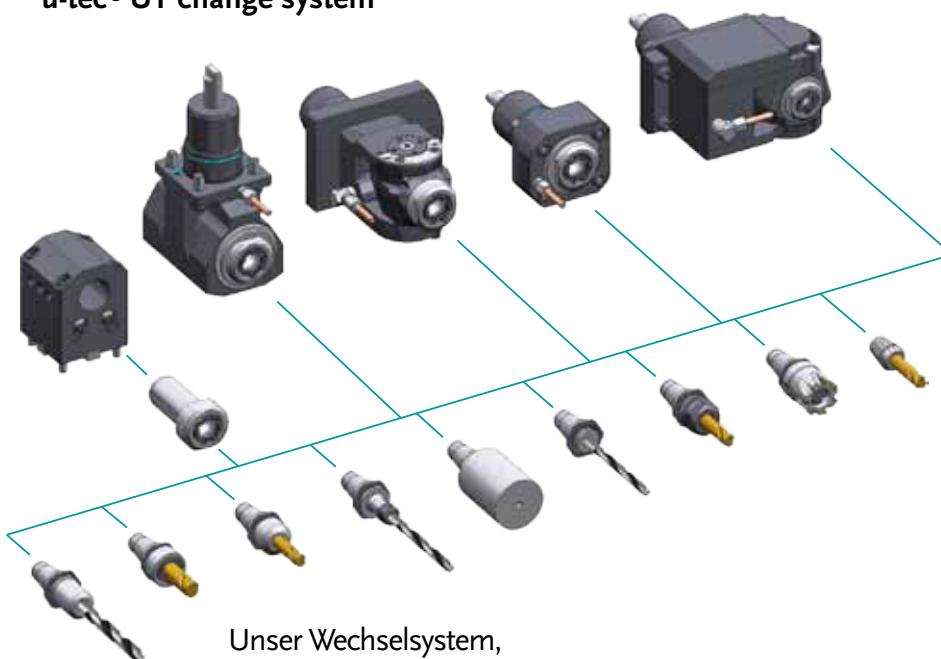

Unser Wechselsystem,
das ALLES möglich macht

Our change system,
that makes EVERYTHING possible

www.heimatec.de
Produkte / u-tec

www.heimatec.com
products / u-tec

► Ausführungen siehe Katalog
versions see catalogue



heimatec®

- heimatec®-Niederlassungen
heimatec® overseas branches
- unsere weltweiten Vertretungen
global representations of heimatec®



Hauptsitz/headquarters

heimatec® GmbH
Präzisionswerkzeuge
Carl-Benz-Straße 4
D- 77871 Renchen
Postfach 11 36
D- 77867 Renchen
Tel.: +49 (78 43) 94 66 0
Fax: +49 (78 43) 94 66 66
heimatec.de
info@heimatec.de

heimatec® Inc.
USA
usa.heimatec.com
USA@heimatec.com

heimatec®-Ost, JSC
Russia
ru.heimatec.com
Russia@heimatec.com

heimatec® Ltd.
Taiwan
tw.heimatec.com
Taiwan@heimatec.com

heimatec®
Singapore
sg.heimatec.com
Singapore@heimatec.com